

PR-26-REFLECTOR ✓ ACTIVE

RAYCHEM

TE Internal #: 991967-000

Heat Shrink Equipment, Discrete, Worldwide, Cable Assembly, Reflector, SolderSleeve Products

[View on TE.com >](#)



Application Tooling > Heat Shrink Equipment



Equipment Processing Type: **Discrete**

Heat Shrink Equipment Region: **Worldwide**

Heat Shrink Equipment Application: **Cable Assembly**

Tooling Type: **Reflector**

Spare Parts Tooling Type: **SolderSleeve Products**

Features

Product Type Features

Spare Parts Tooling Type	SolderSleeve Products
--------------------------	-----------------------

Product Availability

Heat Shrink Equipment Region	Worldwide
------------------------------	-----------

Other

Equipment Processing Type	Discrete
---------------------------	----------

Heat Shrink Equipment Application	Cable Assembly
-----------------------------------	----------------

Tooling Type	Reflector
--------------	-----------

Product Compliance

[For compliance documentation, visit the product page on TE.com>](#)

EU RoHS Directive 2011/65/EU	Compliant
------------------------------	-----------

EU ELV Directive 2000/53/EC	Compliant
-----------------------------	-----------

China RoHS 2 Directive MIIT Order No 32, 2016	No Restricted Materials Above Threshold
---	---

EU REACH Regulation (EC) No. 1907/2006	Current ECHA Candidate List: JUNE 2022 (224) Candidate List Declared Against: JUN 2020 (209) Does not contain REACH SVHC
--	--

Halogen Content	Low Halogen - Br, Cl, F, I < 900 ppm per homogenous material. Also BFR/CFR/PVC Free
-----------------	---

Solder Process Capability

Not applicable for solder process capability

Product Compliance Disclaimer

This information is provided based on reasonable inquiry of our suppliers and represents our current actual knowledge based on the information they provided. This information is subject to change. The part numbers that TE has identified as EU RoHS compliant have a maximum concentration of 0.1% by weight in homogenous materials for lead, hexavalent chromium, mercury, PBB, PBDE, DBP, BBP, DEHP, DIBP, and 0.01% for cadmium, or qualify for an exemption to these limits as defined in the Annexes of Directive 2011/65/EU (RoHS2). Finished electrical and electronic equipment products will be CE marked as required by Directive 2011/65/EU. Components may not be CE marked. Additionally, the part numbers that TE has identified as EU ELV compliant have a maximum concentration of 0.1% by weight in homogenous materials for lead, hexavalent chromium, and mercury, and 0.01% for cadmium, or qualify for an exemption to these limits as defined in the Annexes of Directive 2000/53/EC (ELV). Regarding the REACH Regulation, the information TE provides on SVHC in articles for this part number is based on the latest European Chemicals Agency (ECHA) 'Guidance on requirements for substances in articles' posted at this URL: <https://echa.europa.eu/guidance-documents/guidance-on-reach>

Compatible Parts

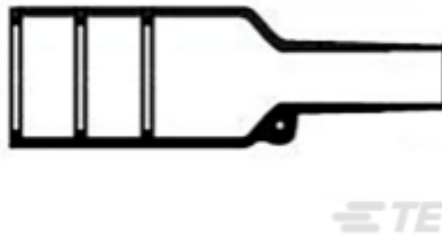

TE Part # CAT-R21-731072
Bulbous Heat Shrink Boots: Lipped, Straight

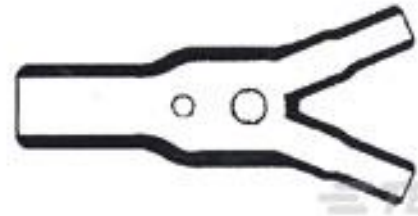

TE Part # 831991-000
382W042-25/225-0



TE Part # CAT-R21-7310723
Low Profile Heat Shrink Boots: Poly Molded, Lipped, Straight



TE Part # CAT-R21-731055422
Heat Shrink Boots: Poly Mold, Lipped



TE Part # CZ3443-000
202D953-4-50/86-0



TE Part # F20649-000
382A012-100-G05/86-0

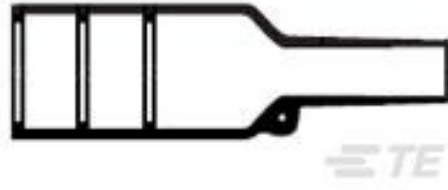

TE Part # 975754-000
202K232-25-01/225-0



TE Part # CV1995-000
203W301-100-G02/86-0



TE Part # 823662-000
382A012-3-04/42-0

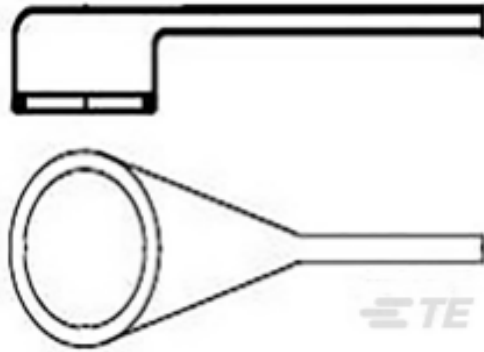

TE Part # 220507-000
222D953-25-G05/225-0



TE Part # 881029-004
222K185-25/225-CS-1858-0



TE Part # CZ1866-000
302A821-4/86-0CS1821



Documents

Product Drawings

[PR-26-REFLECTOR](#)

English

Datasheets & Catalog Pages

[RAYCHEM_TUBING_CATALOG_SEC2_APPLICATION_EQUIPMENT](#)

English

[Raychem Application Tooling](#)

English